

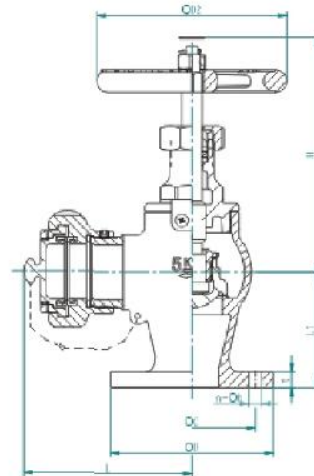

# JIS F7334 Bronze Angle Hose Valve 5K

ZMC Metal  
<http://www.zmcsteel.com>



## MATERIAL SHEET

No:	Parts	Material	No:	Parts	Material
1	Body	JIS H5111-BC6	10	Hexagon Nut	C3604 BD
2	Bonnet	JIS H5111-BC6	11	Split Pin	C2600 W
3	Disc	OR JIS H3250-C 3771 BD or C3771 BE	12	Bonnet Lock	C2600 P
4	Valve Disc Nut		13	Disc Lock Washer	
5	Packing Gland		14	Packing	JIS F7102
6	Gland Nut		15	Name Plate	C2801 P
7	Stem	JIS H3250- C3771 BD/BE	16	Seat Ring	C3771BD/BE
8	Head Screw	C2700W	17	Cap	JIS F7335
9	Hand Wheel	FC200	18	Chain	JIS F7335

## Dimension Sheet

DN	Flange Size									Weight (KGS)
	L	L1	H	D2	D	n	h	C	d3	
15	68	55	120	80	80	4	12	60	M42X2	
25	78	65	145	125	95	4	12	75	M42X2	
40	123.5	85	165	140	120	4	15	95	M42X2	

## ZMC METAL

ADD: ZMC BUILDING, 101-2#, ZHONGSHAN ROAD, HANGZHOU, CHINA

POST CODE: 310003

TEL: +86-571-28938368

FAX: +86-571-87922182,87016758

[HTTP://WWW.ZMCSTEEL.COM](http://www.zmcsteel.com), [HTTP://WWW.ZMCMETAL.COM](http://www.zmcmetal.com),

EMAIL: [INFO@ZMCSTEEL.COM](mailto:info@zmcsteel.com), [SALES@ZMCMETAL.COM](mailto:sales@zmcmetal.com), [ZMCJORGE@GMAIL.COM](mailto:zmcjorge@gmail.com).